



OFFICIAL RESULT

ATLANTA OLYMPIC GAMES

3rd QUALIFYING BOXING CHAMPIONSHIPS

FEBRUARY 25 - MARCH 1, 1996

BANGKOK , THAILAND

3rd OLYMPIC QUALIFYING BOXING

CHAMPIONSHIPS, BANGKOK

COMPETITION SCHEDULE

STARTING DATE							25 FEB	26 FEB	27 FEB	28 FEB	29 FEB	1 MAR	T-B	
STARTING TIME							04.00 P.M.	03.00 P.M.	03.00 P.M.	03.00 P.M.	03.00 P.M.	01.30 P.M.		
W-Kg.	T-E	P	P	Q	S	F								
48	10		2	4	2	1		2		4		2	1	9
51	11		3	4	2	1			3		4	2	1	10
54	13		5	4	2	1		5		4		2	1	12
57	9		1	4	2	1		1		4		2	1	8
60	12		4	4	2	1		4		4		2	1	11
63.5	13		5	4	2	1			5		4	2	1	12
67	9		1	4	2	1		1		4		2	1	8
71	12		4	4	2	1		4		4		2	1	11
75	11		3	4	2	1		3	4		2	2	1	10
81	8			4	2	1			4		2		1	7
91	7			3	2	1			3		2		1	6
91+	5			1	2	1			1		2		1	4
TOTAL	120		28	44	24	12		20	20	20	18	18	12	108

LEGEND:

- W-KG = Weight Categories
- T-E = Total Entries
- P = Preliminary
- Q = Quarter - Finals
- S = Semi - Finals
- F = Finals
- T-B = Total Bouts

3rd OLYMPIC QUALIFYING BOXING
CHAMPIONSHIPS, BANGKOK

25/02/96 27/02/96 29/02/96 01/03/96

Kg. 48

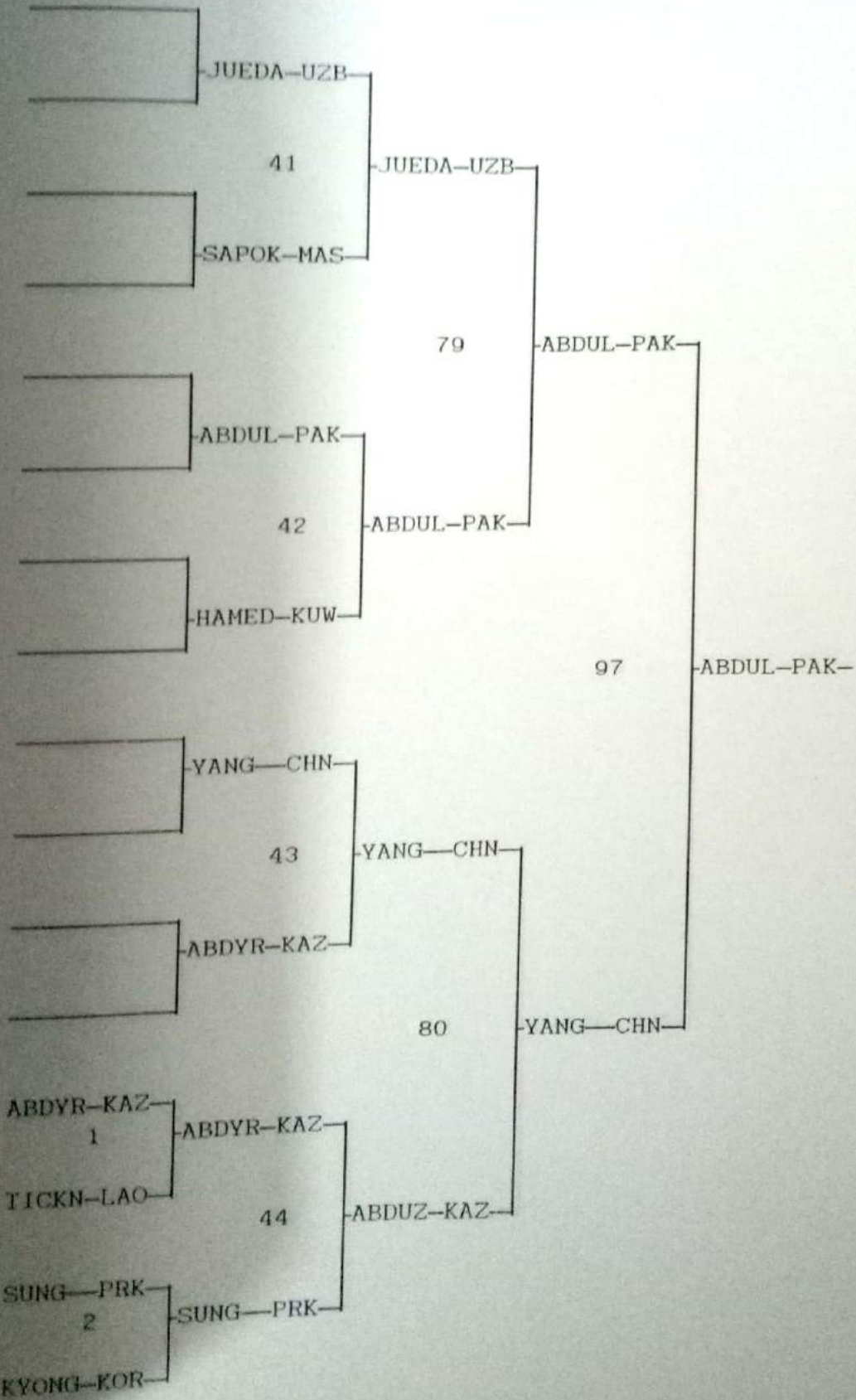

3rd OLYMPIC QUALIFYING BOXING

CHAMPIONSHIPS, BANGKOK

26/02/96 28/02/96 29/02/96 01/03/96

Kg. 51

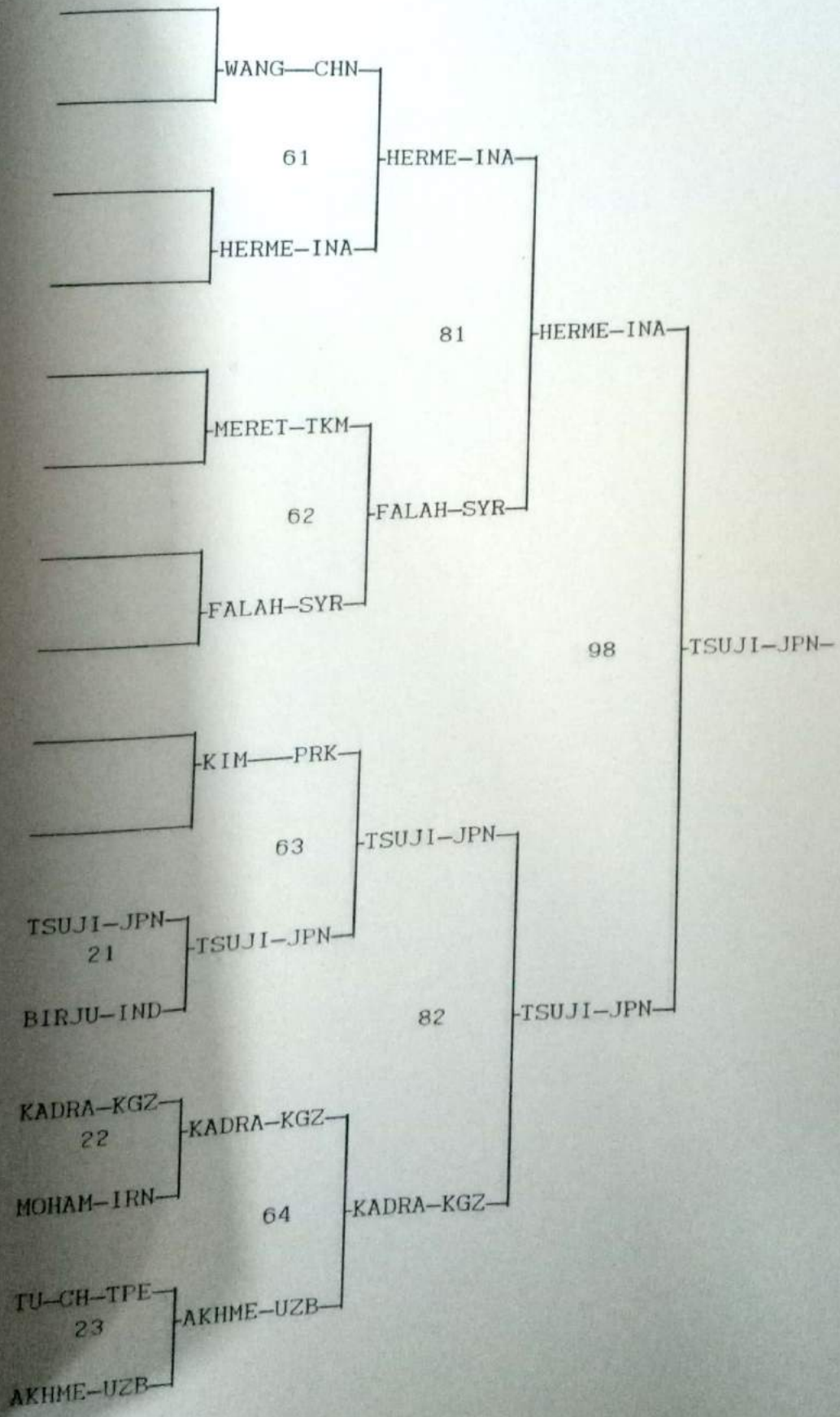

3rd OLYMPIC QUALIFYING BOXING

CHAMPIONSHIPS, BANGKOK

25/2/96 27/2/96 29/2/96 01/03/96

Kg. 54

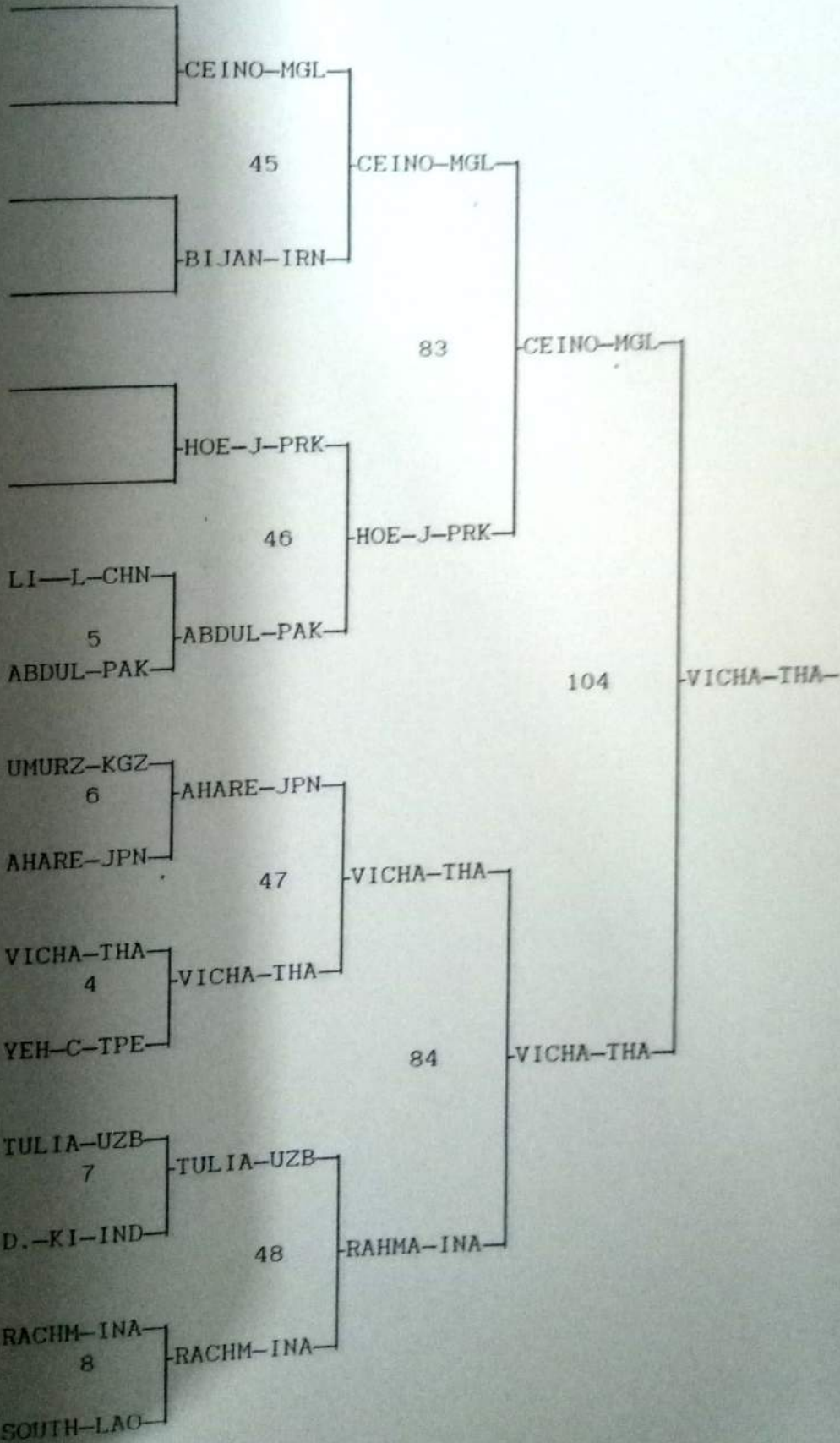

3rd OLYMPIC QUALIFYING BOXING CHAMPIONSHIPS, BANGKOK

25/02/96 27/06/96 29/02/96 01/03/96

Kg . 57

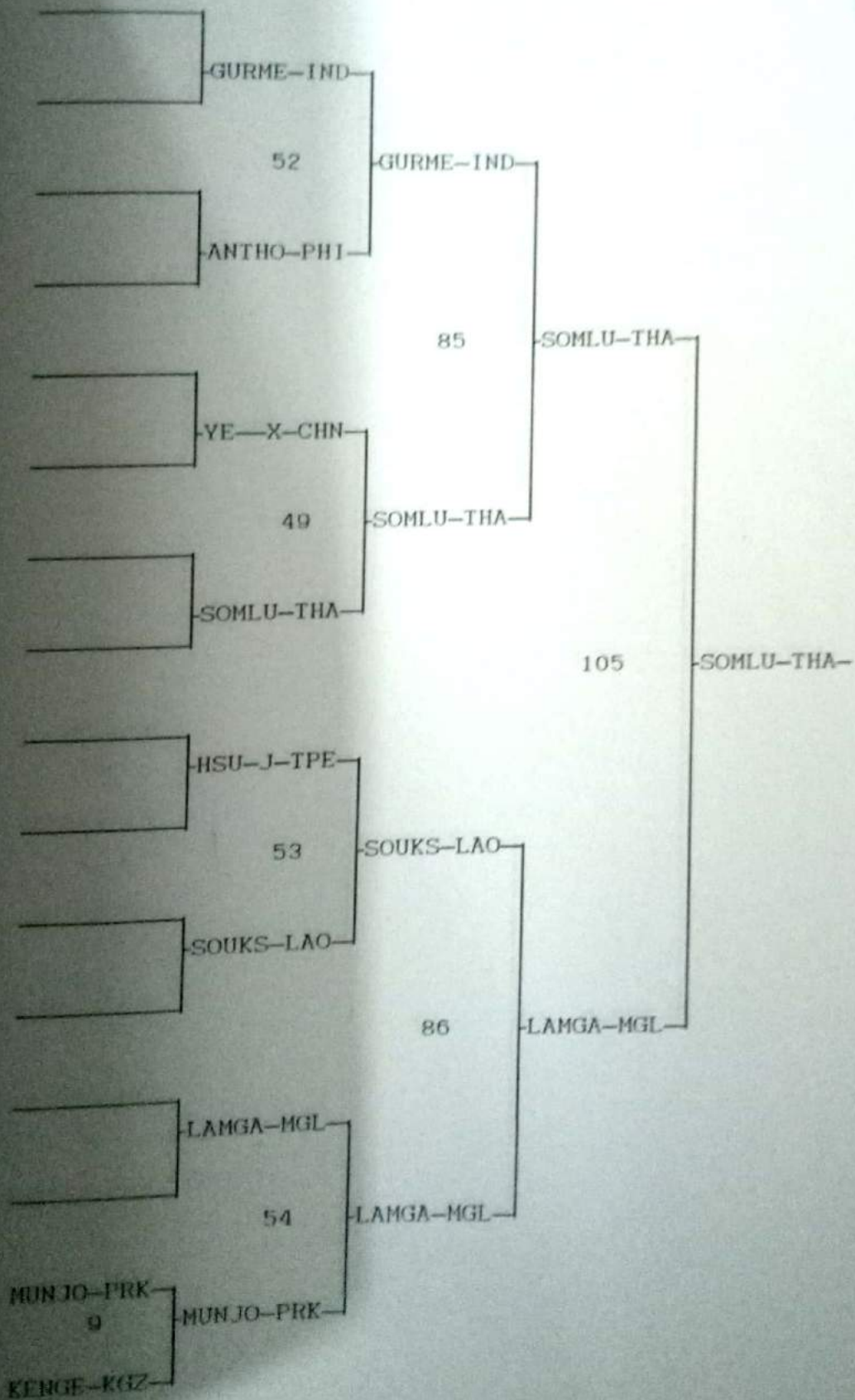

3rd OLYMPIC QUALIFYING BOXING

CHAMPIONSHIPS, BANGKOK

25/02/96 27/02/96 29/02/96 01/03/96

Kg. 60

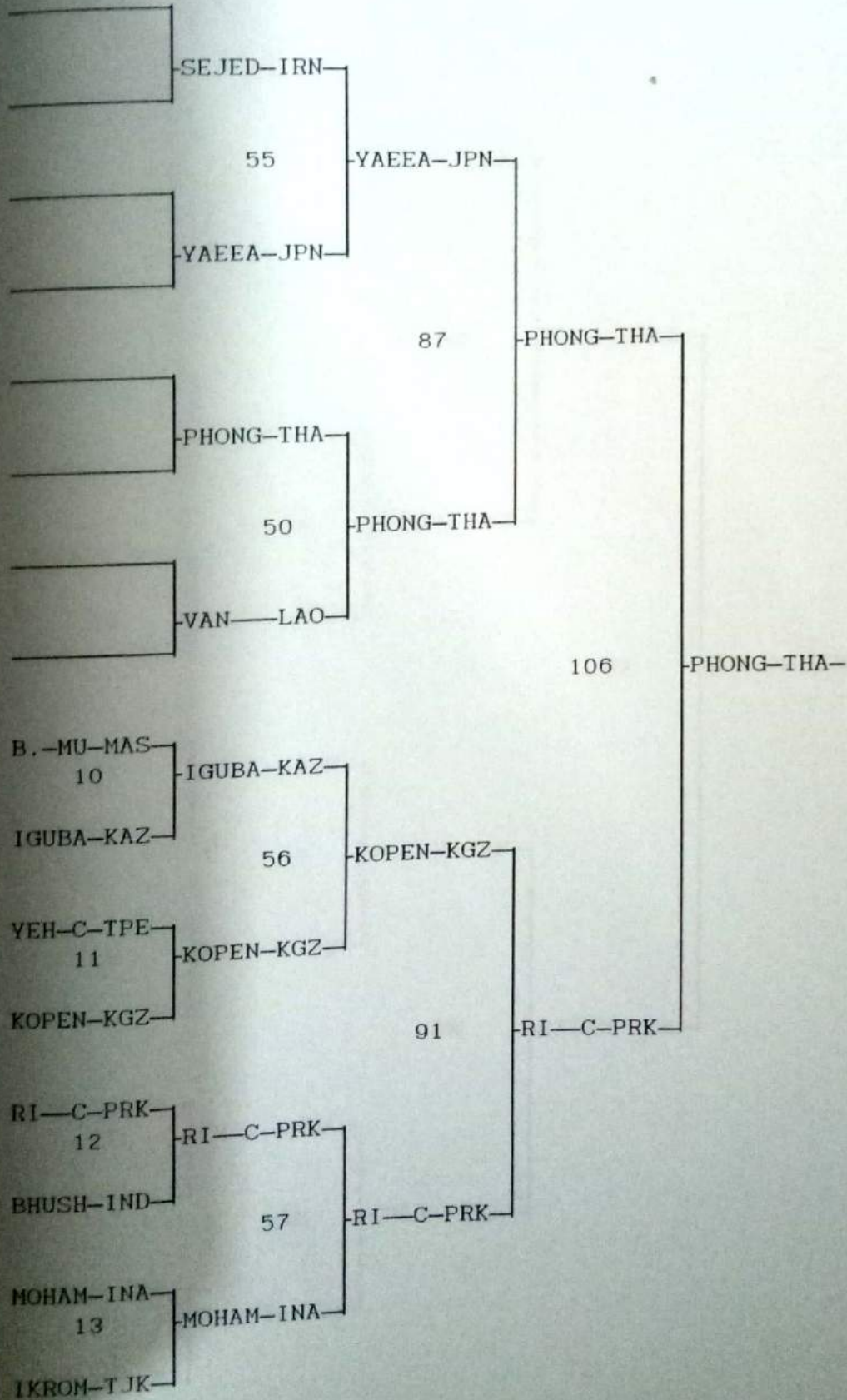

3rd OLYMPIC QUALIFYING BOXING CHAMPIONSHIPS, BANGKOK

26/02/39 28/02/39 29/02/39 01/03/39

Kg. 63.5

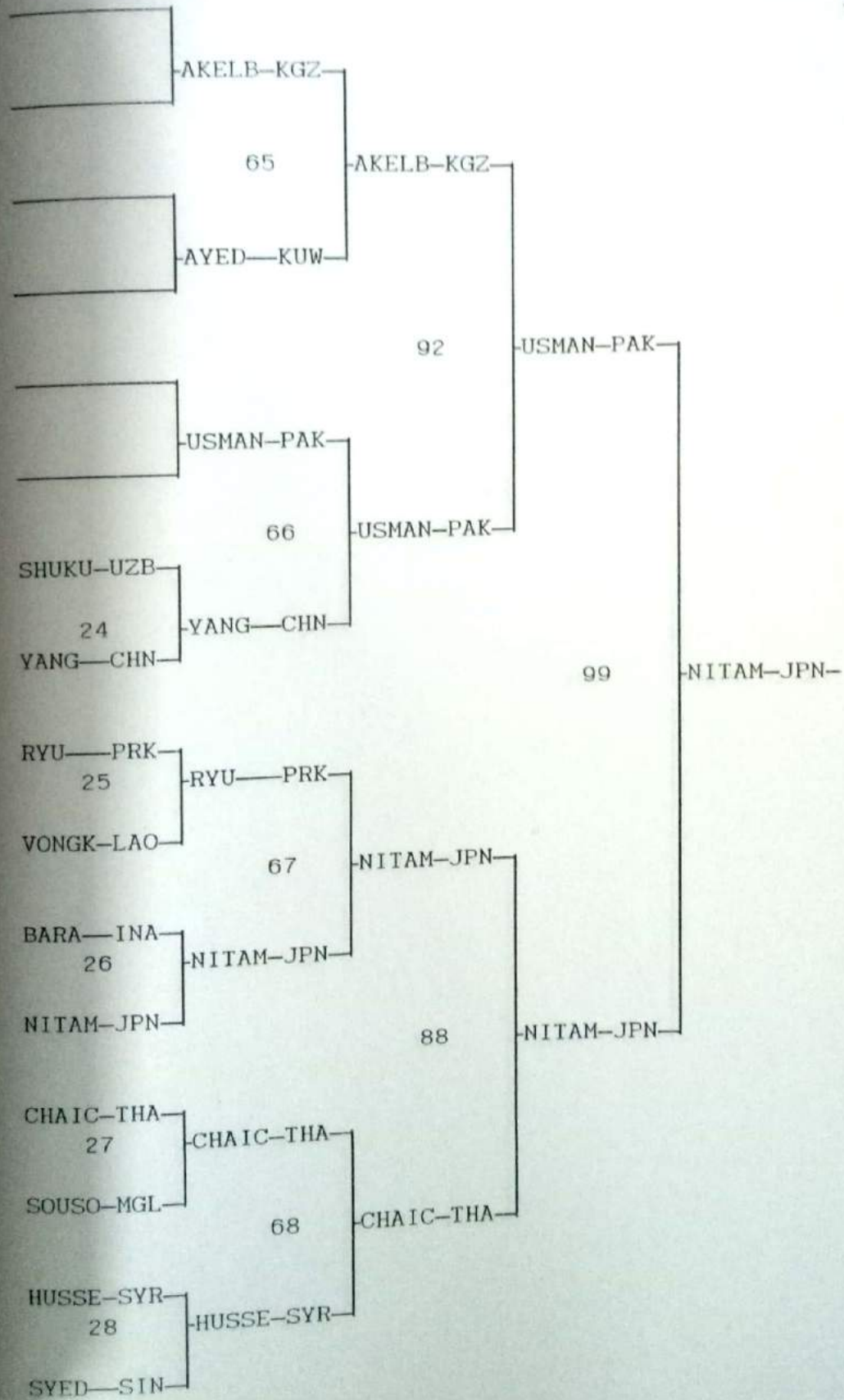

3rd OLYMPIC QUALIFYING BOXING

CHAMPIONSHIPS, BANGKOK

25/02/96 27/12/96 29/12/96 1/3/96

Kg. 67

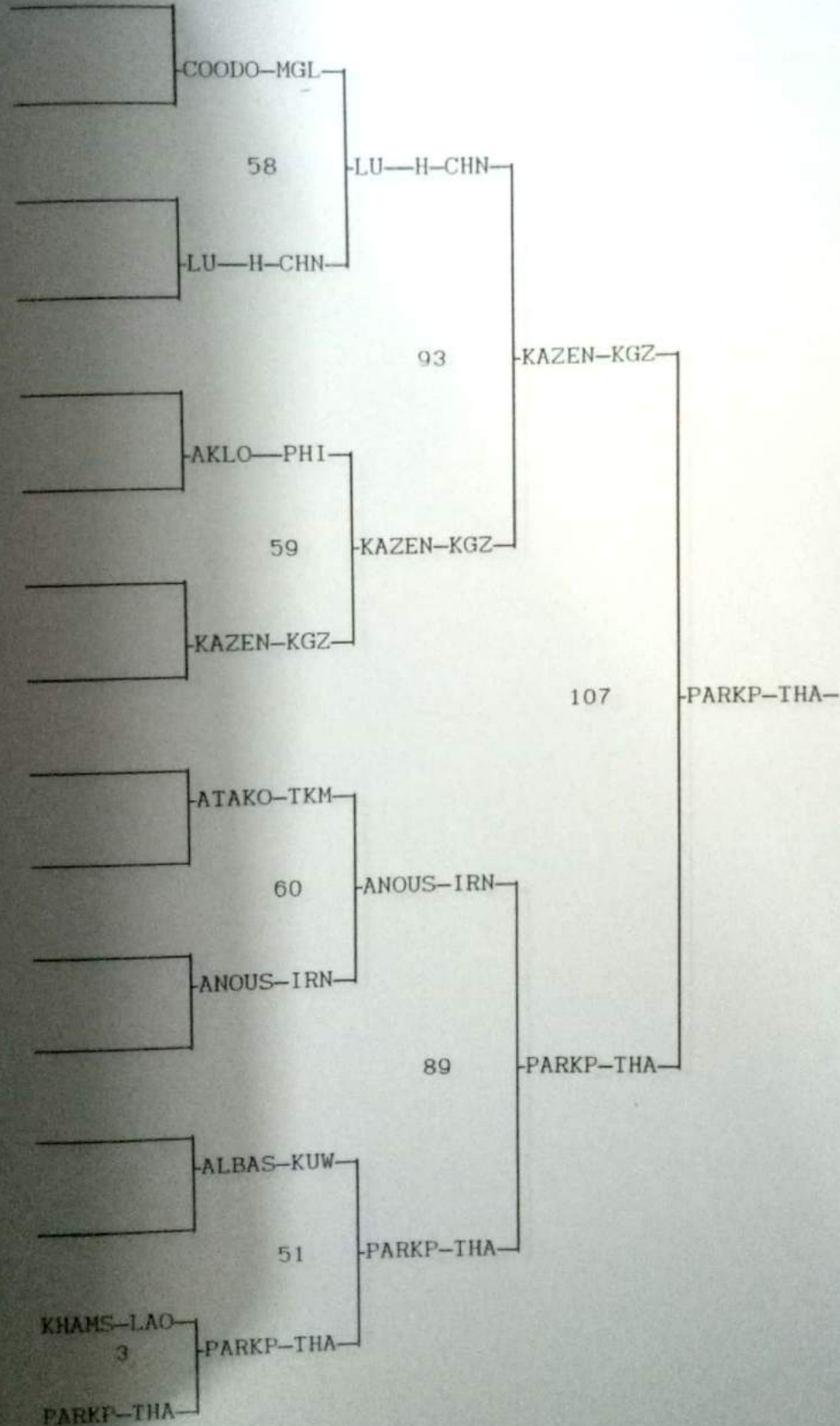

3rd OLYMPIC QUALIFYING BOXING
CHAMPIONSHIPS, BANGKOK

25/2/96 28/2/96 29/2/96 1/3/96

Kg. 71

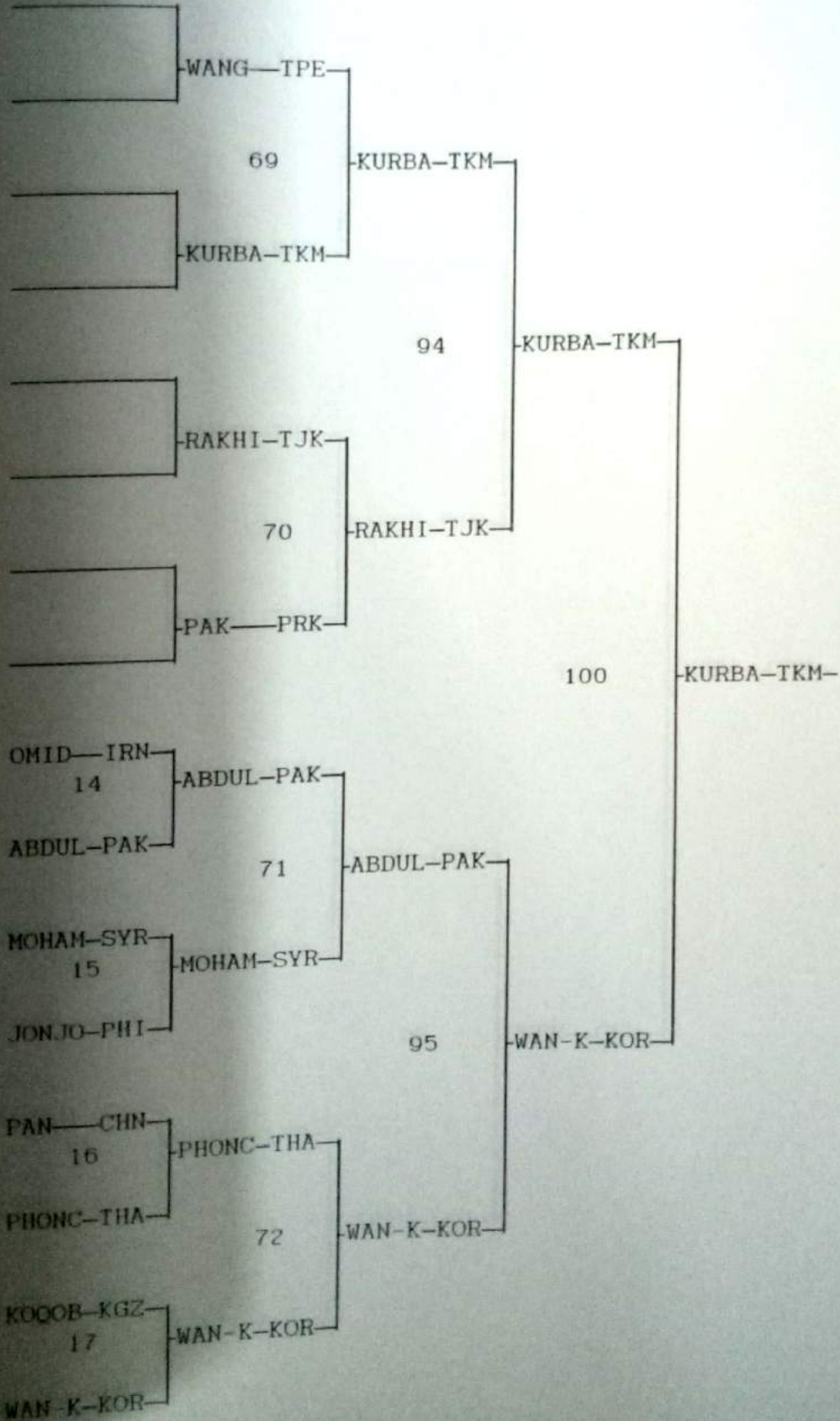

3rd OLYMPIC QUALIFYING BOXING
CHAMPIONSHIPS, BANGKOK

25/2/96 26/2/96 29/2/96 1/3/96

Kg. 75

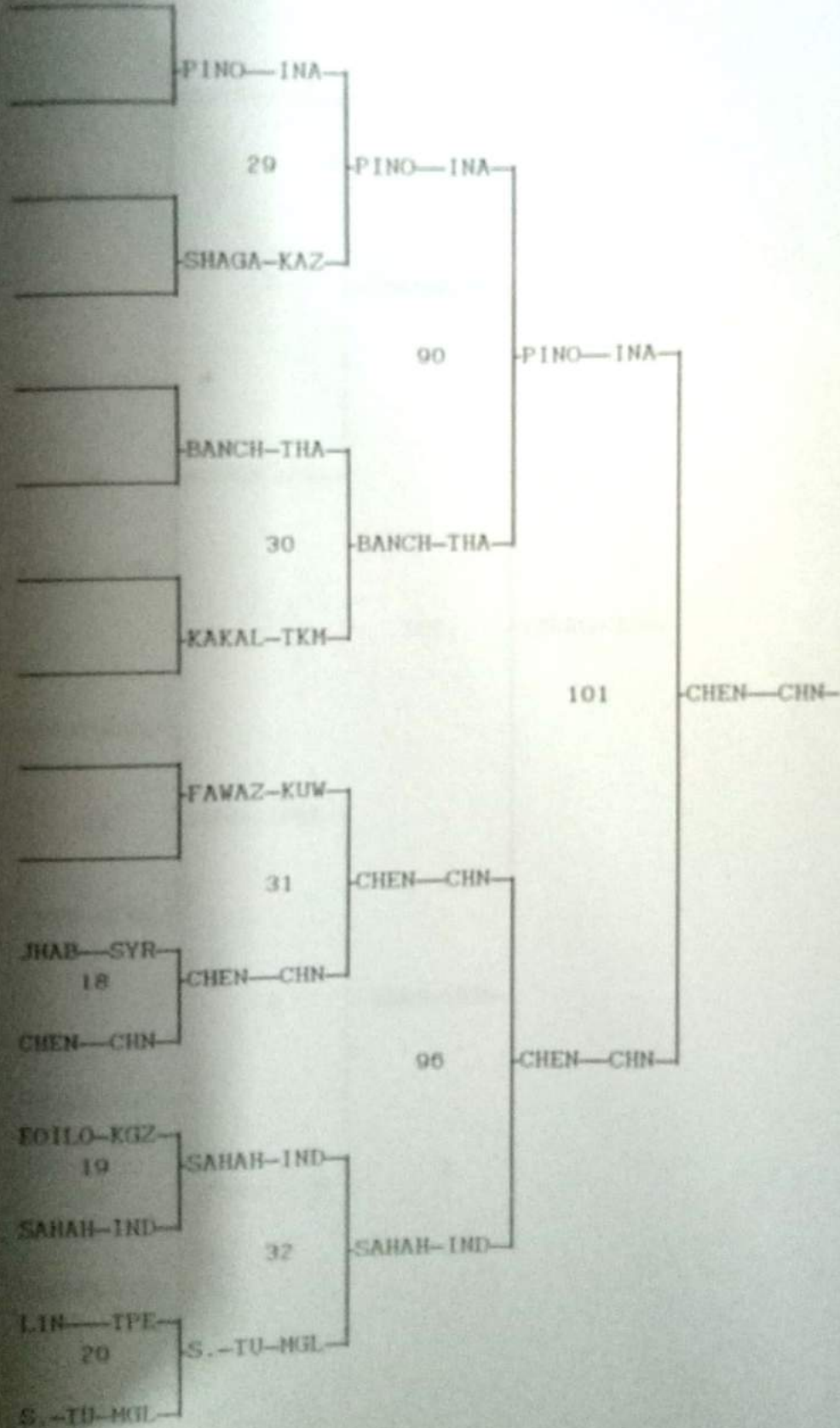

3rd OLYMPIC QUALIFYING BOXING

CHAMPIONSHIPS, BANGKOK

26/2/96 28/2/96 1/3/96

Kg . 81

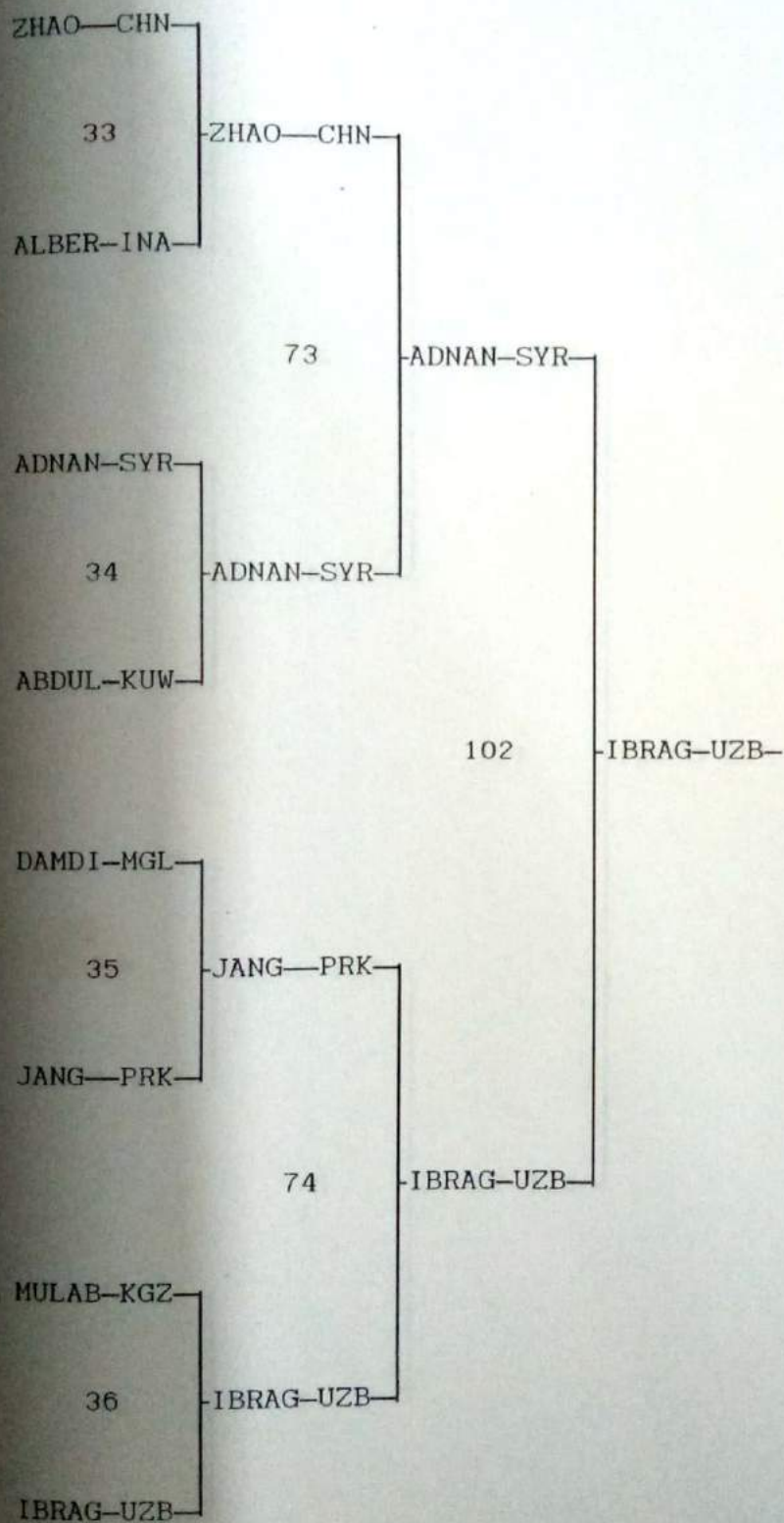

3rd OLYMPIC QUALIFYING BOXING
CHAMPIONSHIPS, BANGKOK

26/2/06

28/2/06

1/3/06

Kg . 91

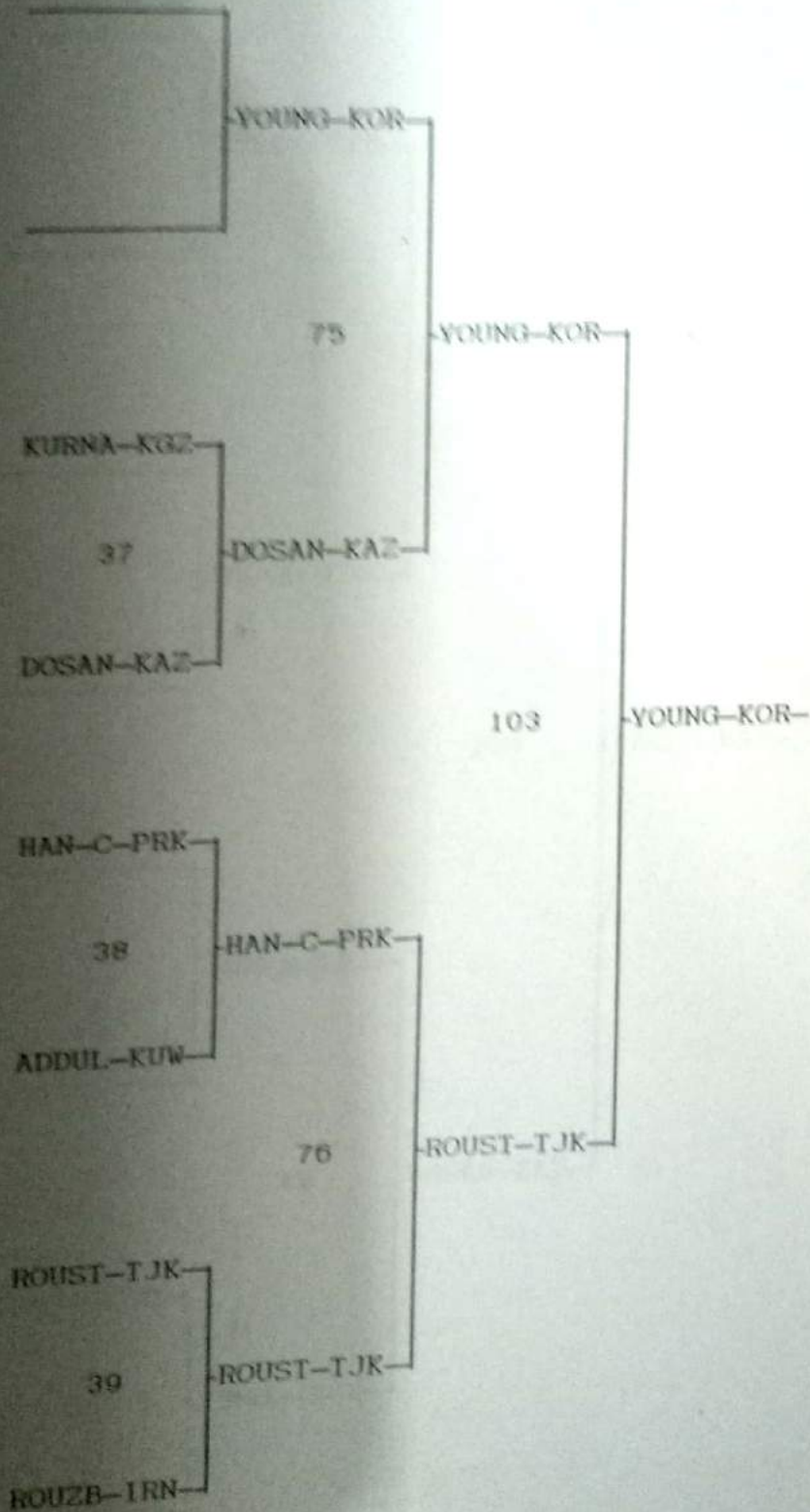

3rd OLYMPIC QUALIFYING BOXING
CHAMPIONSHIPS, BANGKOK

26/2/96 28/2/96 1/3/96

Kg. 91+

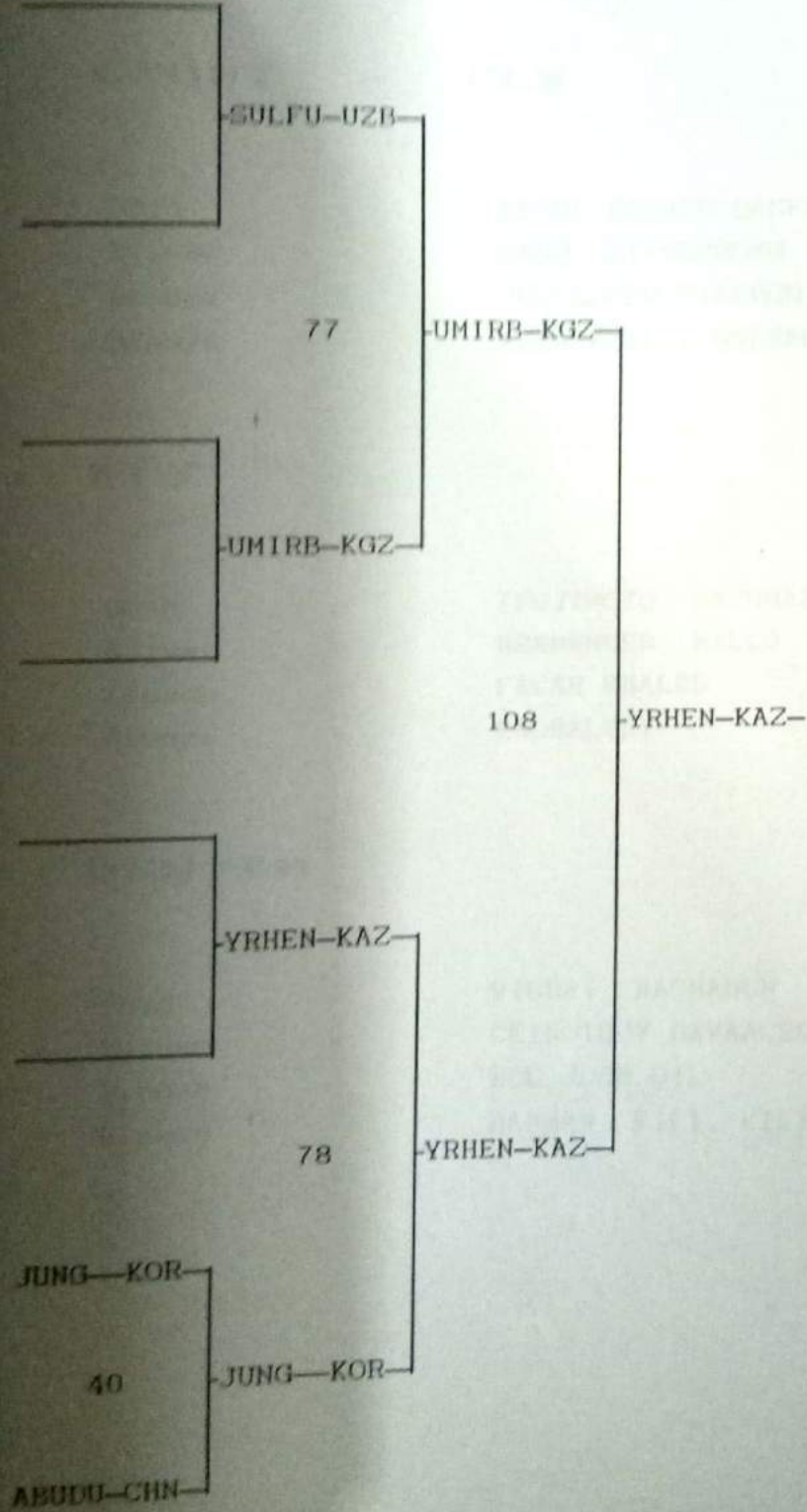

3rd OLYMPIC QUALIFYING BOXING

CHAMPIONSHIPS, BANGKOK

MEDAL WINNERS

LIGHT - FLY Kg. 48

Gold	-	ABDUL RASHID QAMBRANI	(PAK)
Silver	-	YANG XIANGZHONG	(CHN)
Bronze	-	JUEDASUEV DILSHOD	(UZB)
Bronze	-	ABDUZAZAKOV SULTAN	(KAZ)

FLY Kg. 51

Gold	-	TSUJIMOTO KAZUMAZA	(JPN)
Silver	-	HERMENSEN BALLO	(INA)
Bronze	-	FALAH KHALED	(SYR)
Bronze	-	KADRALVEV	(KGZ)

BANTAM Kg. 54

Gold	-	VICHAI RACHANON	(THA)
Silver	-	CEINOIDOV DAVAACEEREN	(MGL)
Bronze	-	HOE, JONG GIL	(PRK)
Bronze	-	RAHMAN KILI, KILI	(INA)

3rd OLYMPIC QUALIFYING BOXING

CHAMPIONSHIPS, BANGKOK

MEDAL WINNERS

FEATHER

Kg. 57

Gold	-	SONLUCK KAMSING	(THA)
Silver	-	LANGAN NARANCHOGT	(MGL)
Bronze	-	GURMEET SINGH	(IND)
Bronze	-	SOUKSAVANE	(LAO)

LIGHT

Kg. 60

Gold	-	PHONGSIT VIANGVISET	(THA)
Silver	-	RI CHOL	(PRK)
Bronze	-	YAEESHII TSUYOSHI	(JPN)
Bronze	-	KOPENKIN	(KGZ)

LIGHT WELTER

Kg. 63.5

Gold	-	NITAMI FUMITAKA	(JPN)
Silver	-	USHAN ULLAH	(PAK)
Bronze	-	AKELBAEV	(KGZ)
Bronze	-	CHAICHOOMPOL C.	(THA)

3rd OLYMPIC QUALIFYING BOXING
CHAMPIONSHIPS, BANGKOK

MEDAL WINNERS

WELTER

Kg. 67

Gold	-	PARKPOOM JANGPHONAK	(THA)
Silver	-	KAZENOV	(KGZ)
Bronze	-	LU HAIFENG	(CHN)
Bronze	-	ANOUSHIRVAN NOURIAN	(IRN)

LIGHT MIDDLE

Kg. 71

Gold	-	KURBANOV SHKHRAT	(TKM)
Silver	-	WAN-KYUN, LEE	(KOR)
Bronze	-	RAKHIMOV BAKHRITOLIN	(TJK)
Bronze	-	ABDUL RASHEED	(PAK)

MIDDLE

Kg. 75

Gold	-	CHEN TAO	(CHN)
Silver	-	PINO BAHARI	(INA)
Bronze	-	BANCHA MALISON	(THA)
Bronze	-	SAHAHABIR THAPA	(IND)

3rd OLYMPIC QUALIFYING BOXING

CHAMPIONSHIPS, BANGKOK

MEDAL WINNERS

LIGHT HEAVY

Kg. 81

Gold	-	IBRAGIMOV TIMUR	(UZB)
Silver	-	ADNAN KADDOUR	(SYR)
Bronze	-	ZHAO YONG	(CHN)
Bronze	-	JANG SONG GEL	(PRK)

HEAVY

Kg. 91

Gold	-	YOUNG-SAM, KO	(KOR)
Silver	-	ROUSTAM SAIDOV	(TJK)
Bronze	-	DOSANOV TALGAT	(KAZ)
Bronze	-	HAN CHOL, NAM	(PRK)

SUPER HEAVY

Kg. 91+

Gold	-	YRHENKD MIKHAIL	(KAZ)
Silver	-	UMIRBEKOV SERIK	(KGZ)
Bronze	-	SULFULUEV DJAMOL	(UZB)
Bronze	-	JUNG HYUN, AN	(KOR)

3rd OLYMPIC QUALIFYING BOXING
CHAMPIONSHIPS, BANGKOK

STATISTICS

PARTICIPANTS No. 120

FIGHTS No. 108

DECISION	ROUND					TOTAL
	1	2	3	4	5	
POINTS	-	-	-	-	-	84
KO	3	-	1	-	-	4
DISQ	-	-	-	-	-	-
RSC	1	-	-	-	-	1
RSC-H	4	2	2	-	-	8
RSC-I	-	-	-	4	1	5
RSC-CCL	-	-	-	-	-	-
RSC-O	-	2	2	-	-	4
RET	-	-	1	-	-	1
WO	-	-	-	-	-	1
TOTAL						108

3rd OLYMPIC QUALIFYING BOXING

CHAMPIONSHIPS, BANGKOK

COMPOSITION OF THE WEIGHT CATEGORIES

No.	Team	48 Kg	51 Kg	54 Kg	57 Kg	60 Kg	63.5 Kg	67 Kg	71 Kg	75 Kg	81 Kg	91 Kg	91+ Kg	Total
1	(CHN)	1	1	1	1	-	1	1	1	1	1	-	1	10
2	(TPE)	-	1	1	1	1	-	-	1	1	-	-	-	6
3	(IND)	-	1	1	1	1	-	-	-	1	-	-	-	5
4	(INA)	-	1	1	-	1	1	-	-	1	1	-	-	6
5	(IRN)	-	1	1	-	1	-	1	1	-	-	1	-	6
6	(JPN)	-	1	1	-	1	1	-	-	-	-	-	-	4
7	(KAZ)	1	-	-	-	1	-	-	-	1	-	1	1	5
8	(KGZ)	1	1	1	1	1	1	1	1	1	1	1	1	12
9	(PRK)	1	1	1	1	1	1	-	1	-	1	1	-	9
10	(KOR)	1	-	-	-	-	-	-	1	-	-	1	1	4
11	(KUW)	1	-	-	-	-	1	1	-	1	1	1	-	6
12	(LAO)	1	-	1	1	1	1	1	-	-	-	-	-	6
13	(MAS)	1	-	-	-	1	-	-	-	-	-	-	-	2
14	(MGL)	-	-	1	1	-	1	1	-	1	1	-	-	6
15	(PAK)	1	-	1	-	-	1	-	1	-	-	-	-	4
16	(PHI)	-	-	-	1	-	-	1	1	-	-	-	-	3
17	(SIN)	-	-	-	-	-	1	-	-	-	-	-	-	1
18	(SYR)	-	1	-	-	-	1	-	1	1	1	-	-	5
19	(TJK)	-	-	-	-	1	-	-	1	-	-	1	-	3
20	(THA)	-	-	1	1	1	1	1	1	1	-	-	-	7
21	(TKM)	-	1	-	-	-	-	1	1	1	-	-	-	4
22	(UZB)	1	1	1	-	-	1	-	-	-	1	-	1	6
TOTAL		10	11	13	9	12	13	9	12	11	8	7	5	120

3rd OLYMPIC QUALIFYING BOXING

CHAMPIONSHIPS, BANGKOK

WEIGHT CATEGORY Kg. 48

- 1). YANG XIANGZHONG (CHN)
- 2). ABDUZAZAKOV SULTAN (KAZ)
- 3). KERIMBEKOV (KGZ)
- 4). SUNG JIN GUK (PRK)
- 5). KYUNG-SUK BAE (KOR)
- 6). HAMED ZJED SANAM (KUW)
- 7). TIKNOY (LAO)
- 8). SAPOK BIKI (MAS)
- 9). ABDUL RASHID QAMBRANI (PAK)
- 10). JUEDASUEV DILSHOD (UZB)

3rd OLYMPIC QUALIFYING BOXING

CHAMPIONSHIPS, BANGKOK

WEIGHT CATEGORY Kg. 51

- 1). WANG JUN (CHN)
- 2). TU CHUNG HSIEN (TPE)
- 3). BIRJU SAH (IND)
- 4). HERMENSEN BALLO (INA)
- 5). MOHAMMAD ASHERI (IRN)
- 6). TSUJIMOTO KAZUHAZA (JPN)
- 7). KADRALVEV (KGZ)
- 8). KIM IL RYOP (PRK)
- 9). FALAH KHALED (SYR)
- 10). MERETNIAZOV ISHANKULI (TKM)
- 11). AKHMEDOV KHIKMAT (UZB)

3rd OLYMPIC QUALIFYING BOXING
CHAMPIONSHIPS, BANGKOK

WEIGHT CATEGORY Kg. 54

- 1). LI LIN (CHN)
- 2). YEH CHUN - CHANG (TPE)
- 3). D. KIRAN SAGAR (IND)
- 4). RAHMAN KILI, KILI (INA)
- 5). BIJAN BATMANI (IRN)
- 6). AHAREN MOTOCHIKA (JPN)
- 7). UMURZAKOV (KGZ)
- 8). HOE JONG GIL (PRK)
- 9). SOUTHONE (LAO)
- 10). CEINOIDOV DAVAACEEREN (MGL)
- 11). ABDUL KHALIGUE (PAK)
- 12). VICHAI RACHANON (THA)
- 13). TULIAKOV TIMUR (UZB)

3rd OLYMPIC QUALIFYING BOXING

CHAMPIONSHIPS, BANGKOK

WEIGHT CATEGORY Kg. 57

- 1). YE XINCHUN (CHN)
- 2). HSU JEN-MAO (TPE)
- 3). GURMEET SINGH (IND)
- 4). KENGEBAEV (KGZ)
- 5). MUNJONG JONG (PRK)
- 6). SOUKSAVANE (LAO)
- 7). LANJAN NARANCHOGT (MGL)
- 8). ANTHONY IGUSQUISA (PHI)
- 9). SOMLUCK KANSING (THA)

3rd OLYMPIC QUALIFYING BOXING

CHAMPIONSHIPS, BANGKOK

WEIGHT CATEGORY Kg. 60

- | | | |
|------|---------------------|-------|
| 1). | YEH CHUN HSIANG | (TPE) |
| 2). | BHUSHAN SAINI | (IND) |
| 3). | MOHAMMAD ALFARIDZI | (INA) |
| 4). | SEJED H. N. RAVESH | (IRN) |
| 5). | YAEASHI TSUYOSHI | (JPN) |
| 6). | IGUBAYEV ASLAN | (KAZ) |
| 7). | KOPENKIN | (KGZ) |
| 8). | RI CHOL | (PRK) |
| 9). | VAN XAY | (LAO) |
| 10). | B. MURUAUTHEVAN | (MAS) |
| 11). | IKROM BOBOEV | (TJK) |
| 12). | PHONGSIT VIANGVISET | (THA) |

3rd OLYMPIC QUALIFYING BOXING
CHAMPIONSHIPS, BANGKOK

WEIGHT CATEGORY Kg. 63.5

- 1). YANG YI (CHN)
- 2). BARA GOMIES (INA)
- 3). NITAMI FUMITAKA (JPN)
- 4). AKELBAEV (KGZ)
- 5). RYU WON CHOL (PRK)
- 6). AYED AL SHEMIRI (KUW)
- 7). VONGKOT CHINDA (LAO)
- 8). SOUSORBARAM ZOORIGOO (MGL)
- 9). USMAN ULLAH (PAK)
- 10). SYED MUHAMMAD FAHMY (SIN)
- 11). HUSSEIN OTHMAN (SYR)
- 12). CHAICHOOMPOL C. (THA)
- 13). SHUKUROV KAMIL JON (UZB)

3rd OLYMPIC QUALIFYING BOXING

CHAMPIONSHIPS, BANGKOK

WEIGHT CATEGORY Kg. 67

- 1). LU HAIFENG (CHN)
- 2). ANOUSHIRVAN NOURIAN (IRN)
- 3). KAZENOV (KGZ)
- 4). ALBASHIR ABDUL RAHMAN (KUW)
- 5). KHAMSAVATH VILAYPHONE (LAO)
- 6). COODOL BATNASAN (MGL)
- 7). AKLO CHAVEZ (PHI)
- 8). PARKPOOM JANGPHONAK (THA)
- 9). ATAKOV NOVDEDIN (TKM)

3rd OLYMPIC QUALIFYING BOXING

CHAMPIONSHIPS, BANGKOK

WEIGHT CATEGORY Kg. 71

- 1). PAN FENG (CHN)
- 2). WANG CHUNG YUAN (TPE)
- 3). OMID RASHID (IRN)
- 4). KOQOBKOV (KGZ)
- 5). PAK JONG SAM (PRK)
- 6). WAN-KYUN, LEE (KOR)
- 7). ABDUL RASHEED (PAK)
- 8). JONJON TAMAYO (PHI)
- 9). MOHAMAD GHYASSE TAIFOUS (SYR)
- 10). RAKHIMOV BAKHRITOLIN (TJK)
- 11). PHONCHAI THONGBURAN (THA)
- 12). KURBANOV SHKHRAT (TKM)

3rd OLYMPIC QUALIFYING BOXING
CHAMPIONSHIPS, BANGKOK

WEIGHT CATEGORY Kg. 75

- | | | |
|------|-------------------|-------|
| 1). | CHEN TAO | (CHN) |
| 2). | LIN CHEN HAO | (TPE) |
| 3). | SAHAHABIR THAPA | (IND) |
| 4). | PINO BAHARI | (INA) |
| 5). | SHAGATAFR KANOT | (KAZ) |
| 6). | EOILO | (KGZ) |
| 7). | FAWAZ AL MUTARI | (KUW) |
| 8). | S. TUMENBAYAR | (MGL) |
| 9). | JHAB YASSH | (SYR) |
| 10). | BANCHA MALISON | (THA) |
| 11). | KAKALIEV NURGELDI | (TKM) |

3rd OLYMPIC QUALIFYING BOXING
CHAMPIONSHIPS, BANGKOK

WEIGHT CATEGORY Kg. 81

- | | | |
|-----|-------------------|-------|
| 1). | ZHAO YONG | (CHN) |
| 2). | ALBERTH PAPILAYA | (INA) |
| 3). | MULABAEV | (KGZ) |
| 4). | JANG SONG GEL | (PRK) |
| 5). | ABDULHADI AL AJMI | (KUW) |
| 6). | DAMDIN ZUL | (MGL) |
| 7). | ADNAN KADDOUR | (SYR) |
| 8). | IBRAGIMOV TIMUR | (UZB) |

3rd OLYMPIC QUALIFYING BOXING
CHAMPIONSHIPS, BANGKOK

WEIGHT CATEGORY Kg. 91

- | | | |
|-----|--------------------|-------|
| 1). | ROUZBEH NIKNEJAD | (IRN) |
| 2). | DOSANOV TALGAT | (KAZ) |
| 3). | KURNAVKA | (KGZ) |
| 4). | HAN CHOL, NAM | (PRK) |
| 5). | YOUNG-SAM, KO | (KOR) |
| 6). | ABDULLAH AL QALLAF | (KUW) |
| 7). | ROUSTAM SAIDOV | (TJK) |

3rd OLYMPIC QUALIFYING BOXING
CHAMPIONSHIPS, BANGKOK

WEIGHT CATEGORY Kg. 91+

- 1). ABUDUXIKEER MIJIT (CHN)
- 2). YRHENKD MIKHAIL (KAZ)
- 3). UMIRBEKOV SERIK (KGZ)
- 4). JUNG HYUN, AN (KOR)
- 5). SULFULUEV DJAMOL (UZB)